

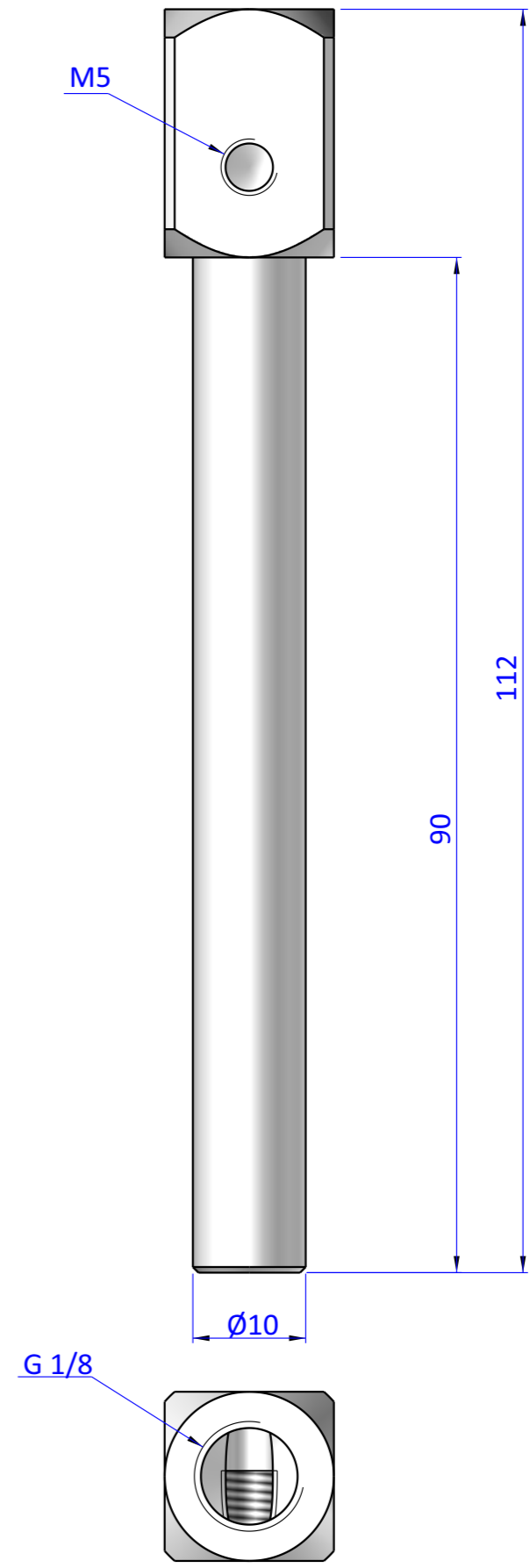

THE PROPERTY OF THE DRAWING IS ESTABLISHED BY LAW. IT IS FORBIDDEN TO PRODUCE OR SHOW IT TO THIRD PART. WITHOUT A WRITTEN AGREEMENT.

Item	Name	Qty.
1	GSE.10.18.M5.90	1

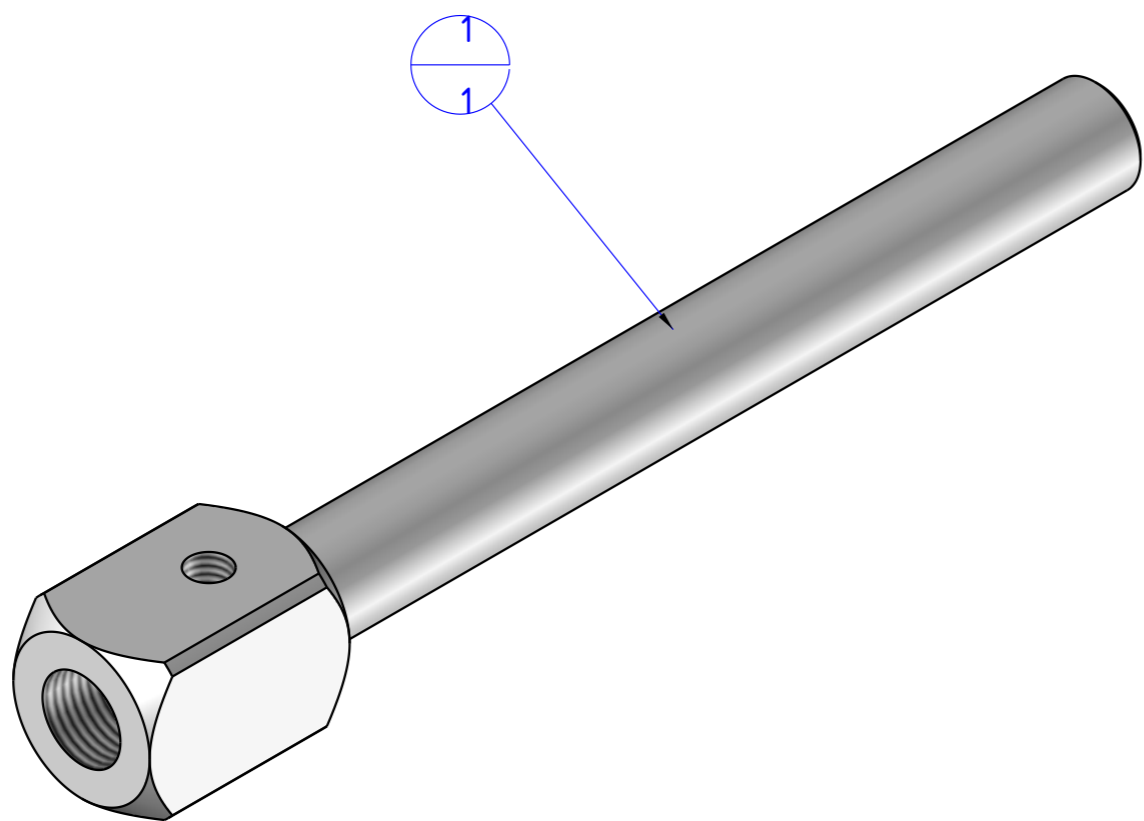

Format A3
UNI 936-76

 FPS SERVICES AUTOMATION		DESIGNED FROM FPS Automation		REVIEW A
		DATE 17/09/2020	WEIGHT 0,025kg	
GENERAL TOLERANCE UNI - ISO 2768 CLASSE f	DESCRIPTION CA.GSE.1018M590	CODE CA.GSE.1018M590		